

RIGblaster pro

**the complete computer interface
for your radio**

OWNERS MANUAL

West Mountain Radio
www.westmountainradio.com

18 Sheehan Avenue, Norwalk, CT 06854 tel 203-853-8080 fax 203-299-0232

Rev 7 – Oct 2004

PREFACE

Thank you for buying the *RIGblaster pro*. Whether you are upgrading from another RIGblaster, another sound card interface, or this is your first interface, we think you will be pleased with the capabilities of the pro. After building close to 20,000 RIGblaster sound card interfaces we felt we should introduce an interface that does everything that can possibly be done with a computer and a radio.

For basic Amateur Radio sound card operation the *RIGblaster pro* is easier to set up and operate than any other sound card interface. Front panel status indicators show at a glance, signal routing, audio signal level and activation of PTT, CW and FSK control and keying.

The cable hookups are as simple as all other model *RIGblasters* for the same function. The *RIGblaster pro* does, however, offer many more possibilities, for instance, four ways to connect your receive audio. Understandably, there are many additional connection and configuration options to provide the full functionality.

To do whatever you would like that is possible with a *RIGblaster pro* choose the optional connections described in this manual. Feel free to try all the possible functions one at a time or all at once depending on your desire to experiment. In the spirit of Amateur Radio, that is what it is all about!

The *RIGblaster pro* was conceived as a platform to support all Amateur Radio sound card, keying and rig control software, even software that has not yet been written.

CHOOSING A MOUNTING LOCATION

The supplied microphone cable is 3 feet long and the computer cables are 6 feet long. Choose a location that allows these cables to reach your radio and your computer. You may extend the computer cables within reason. You should have the computer at your operating position with the radios. Do not attempt to run the *RIGblaster pro* with a computer across the room, especially if it is on a different house wiring circuit than your ham station.

Put it where you can see and operate it easily and where you will have access to the back panel.

The top cover can be removed without disconnecting the cables for easy access to the internal jumpers.

If you will be using a hand microphone with a coiled cord, consider the tug on the cord. The *RIGblaster pro* is fairly heavy but could be pulled around with a coiled mic cord. You can use the supplied double stick pads as an easy way to secure it.

Locate the *RIGblaster pro* at least 18 inches away from anything that can have a strong magnetic field, such as transformer type power supplies, amplifiers, CRT type monitors or rotor control boxes. Do not put the *RIGblaster pro* in strong RF fields.

The *RIGblaster pro* requires little or no ventilation and can be put anywhere that does not block the ventilation for another piece of equipment that does require ventilation.

TABLE OF CONTENTS

PREFACE	1
UNPACKING.....	3
PLEASE NOTE:.....	3
PANEL DESCRIPTION	4
FRONT PANEL.....	4
REAR PANEL	6
INSTALLATION & CONNECTIONS	8
STEP 1 - INSTALL SOFTWARE AND START RECEIVING	8
STEP 2 - INSTALL JUMPERS and CONNECT MIC CABLE	8
STEP 3 - CONNECT SERIAL CABLE(s).....	9
STEP 4 - CONNECT AUDIO CABLES.....	10
STEP 5 - SET AUDIO LEVELS	12
STEP 6 - CW CABLING AND SETUP.....	13
STEP 7 - FSK CABLING AND SETUP.....	13
STEP 8 - RIG CONTROL CABLING AND SETUP.....	14
STEP 9 - ADVANCED AUDIO PROCESSING CONSIDERATIONS	16
STATION HOOKUP DIAGRAM (basic sound card function).....	17
STATION HOOKUP DIAGRAM (all features & functions).....	19
MICROPHONE JUMPER DIAGRAMS.....	22
8 PIN SCREW ON MICROPHONE JUMPERING	22
RJ45 MODULAR STYLE MICROPHONE JUMPERING.....	24
RECEIVE AUDIO AVAILABLE ON THE MIC CONNECTOR.....	25
HOW WE CREATED OUR JUMPERING DIAGRAMS	26
MIC MODE JUMPER – P6	27
COM PORT & RIG CONTROL JUMPER DIAGRAMS (P16).....	28
PTT LOOP JUMPER – P5.....	30
RECEIVE AUDIO CONNECTION OPTIONS.....	31
TROUBLESHOOTING TIPS.....	33
INDEX	34

UNPACKING



Items included with the *RIGblaster pro*

- 1 Power Supply Isolated 12VDC
- 1 CD-ROM WMR Collection of Third Party Software
- 1 Microphone Cable (RJ45 to 8 pin screw on)
- 1 DB9M to DB9F Serial Cable
- 6 1/8 inch (3.5mm) Stereo Mini Plug 6' Patch Cords
- 1 Owners Manual (not pictured)
- 1 Patch Cord Label Set
- 1 Accessories Kit (that contains)
 - 11 White Wire Jumpers
 - 6 Blue Shunt Jumpers
 - 1 Adapter – 1/8 inch (3.5mm) Mini (female) to 1/4 inch Plug
 - 4 3M Adhesive Pads (not pictured)

PLEASE NOTE:

In this manual we will refer to the sound device on a computer as “Sound Card”. We understand many computer sound devices are integrated onto the motherboard of the computer. We will stick to the more familiar wording “Sound Card”.

The words “Radio”, “Transceiver” and “Rig” as used within this document are synonymous. Also “c.s.” as used throughout this document means audio generated by the sound card, or Computer Sound.

PANEL DESCRIPTION

FRONT PANEL

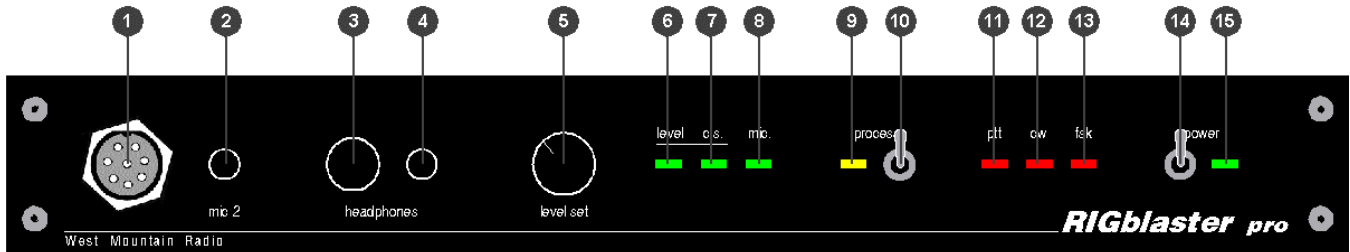

- 1 - MICROPHONE CONNECTOR, 8-Pin Screw-on Microphone Connector – connects your radio microphone to the *RIGblaster pro*. (May be used as mic out on a radio with an RJ45 microphone connector)
- 2 - “mic 2”, an auxiliary mic connector for connecting a microphone with a 1/8 inch (3.5mm) connector. Main mic does not need to be disconnected as this jack switches over automatically.
- 3 - COMPUTER MONITOR HEADPHONE JACK – Accepts Headphones with a ¼ inch Jack
- 4 - COMPUTER MONITOR HEADPHONE JACK – Accepts Headphones with a 1/8 inch (3.5mm) Jack
- 5 - “level set” – For adjusting the audio level being fed from the computer audio Line Out or headphone out to the Mic input of the attached radio in order to set transmit drive level.
- 6 - “level” LED – A Green LED that indicates the presence of sound card audio in Receive Mode. In Transmit mode, it indicates sufficient sound card audio to adequately modulate most radios.
- 7 - “c.s.” LED – A Green LED, when on, indicates computer sound (c.s.) is being fed to the radio. When this LED is on, the direct microphone path to the radio is disconnected.
- 8 - “mic.” LED – A Green LED, when on, indicates the microphone is available to the radio. See STEP 9 ADVANCED AUDIO PROCESSING CONSIDERATIONS later in this manual for more information.
- 9 - “process” LED – A Yellow LED indicating that the *RIGblaster pro* is in Process Mode This LED will turn on only when the “process Switch” is on and PTT is pressed on the attached mic or via an attached PTT switch/foot switch or when PTT is activated by software through the serial port connection from the computer.
- 10 - “process” Switch – Turns process mode on or off. Up is ON and down is OFF. This switch must be OFF when the *RIGblaster pro* is turned off for your mic to work normally. If the “process Switch” is OFF, microphone audio is fed directly to the radio. When the “process Switch” is ON mic audio can be connected via the *RIGblaster pro* to the computers mic input and back into the radio. Please see STEP 9 ADVANCED AUDIO PROCESSING CONSIDERATIONS later in this manual for more information about Process Mode.
- 11 - “ptt” LED – This Red LED indicates when PTT is activated by your mic, foot switch or by software through the serial port connection from the computer.

PANEL DESCRIPTION continued

FRONT PANEL continued

12 - “cw” LED – This Red LED indicates when CW keying is active with appropriate software for CW keying. This LED may be on with the *RIGblaster pro* turned off if the serial port to the computer is connected and the DTR line of that serial port is active.

13 - “fsk” LED – This Red LED blinks when FSK keying is active with appropriate software for FSK keying. Under certain conditions, this LED may be on without an active FSK program running in the computer if the serial port to the computer is connected and the TXD line of that serial port is in an up state. This condition can also occur with some USB to serial port converters.

14 - “power” SWITCH – Turns power ON and OFF. Up is ON and down is OFF.

15 - “power” LED – a Green LED indicating the *RIGblaster pro* is turned on.

PANEL DESCRIPTION continued

REAR PANEL

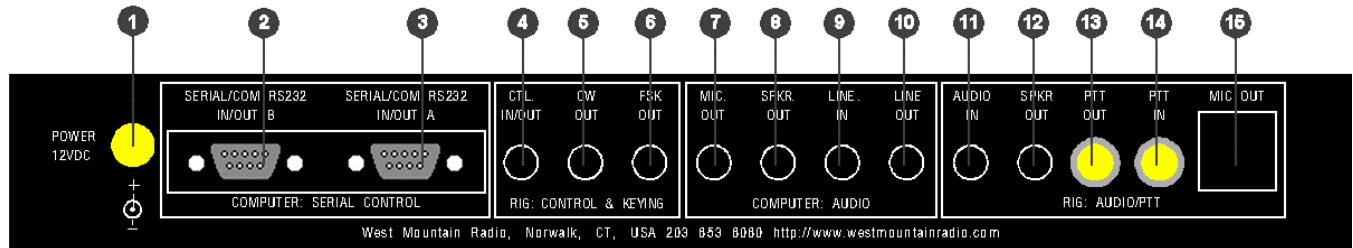

① - POWER INPUT – 12 VDC Input – connects the Supplied Power Supply to the *RIGblaster pro*.

COMPUTER: SERIAL CONTROL

② - SERIAL/COM RS232 IN/OUT B – DB9 - For connection to a second available computer serial port. This is the secondary jack and depending on the software you wish to run, this may be used for ONLY ONE of the following functions:

FSK keying (if SERIAL/COM RS232 IN/OUT A is being used for Rig Control)

Rig Control (if SERIAL/COM RS232 IN/OUT A is being used for FSK)

Rig Control pass through from SERIAL/COM RS232 IN/OUT A (only if your radio has a DB9 Rig Control jack)

③ - SERIAL/COM RS232 IN/OUT A – DB9 - For connection to an available computer serial port. This is the primary jack and depending on the software you wish to run, this may be used for ONLY ONE of the following combination of functions:

PTT Control, CW Keying and Rig Control

PTT Control, CW Keying and FSK Keying

See COM PORT & RIG CONTROL JUMPER DIAGRAMS later in this manual.

RIG: CONTROL & KEYING

④ - CTL. IN/OUT – 1/8 MINI JACK - for connection to ICOM or TenTec radios with a CI-V REMOTE CONTROL JACK for controlling ICOM or TenTec radios with appropriate Rig Control software. This jack is also used to connect to Yaesu radios that have DIN jack TTL CAT capability for controlling Yaesu radios with appropriate Rig Control software. Specific jumpering on the P16 jumper block inside the *RIGblaster pro* is required for ICOM, TenTec or Yaesu radios. When jumpered for ICOM radios, both transmitted and received data are on the tip in relation to the sleeve and there is no connection to the ring. When jumpered for Yaesu, received data from the radio is on the tip and transmitted data to the radio is on the ring, both are in relation to ground on the sleeve. See COM PORT & RIG CONTROL JUMPER DIAGRAMS later in this manual for additional information about Rig Control.

⑤ - CW OUT – 1/8 MINI JACK - for connection to the CW straight key jack on your radio for computer CW keying with appropriate software. Compatible with solid state radios that key with positive pull down.

⑥ - FSK OUT – 1/8 MINI JACK - for connection to the FSK input of your radio for computer FSK keying with appropriate software. Compatible with solid state radios that key with positive pull down.

PANEL DESCRIPTION continued

REAR PANEL continued

COMPUTER: AUDIO

7 - MIC. OUT – 1/8 MINI JACK - for connection to Mic In on your Desktop computer. (May not apply to LapTop Computers where Mic In is used for Receive Audio input to the computer soundcard) This provides the path for connecting your radio microphone to your computer sound Mic In. This output must be activated with the jumper on the P6 jumper block. See the section titled MIC MODE JUMPER – P6 later in this manual.

8 - SPKR OUT – 1/8 MINI JACK - Plug your computer speakers into this jack.

9 - LINE IN – 1/8 MINI JACK - for connection to the computer sound Line Out. (Speaker Out for un-amplified computer speakers, headphone out for a LapTop)

10 - LINE OUT – 1/8 MINI JACK – for connection to the computer sound Line In. (Mic In on LapTops)

RIG: AUDIO/PTT

11 - AUDIO IN – 1/8 MINI JACK – for connection to either fixed or variable line or speaker level audio from your radio. Not used if receive audio is taken directly from the P1 jumper block. See the section titled RECEIVE AUDIO AVAILABLE ON THE MICROPHONE CONNECTOR later in this manual.

12 - SPKR OUT – 1/8 MINI JACK – for connection of your radio external speaker. Used in cases where the radio external speaker output is used to supply audio to the computer sound Line In. If you use fixed or line level audio from your radio to AUDIO IN, no. 11 above, this jack will not be used.

13 - PTT OUT – RCA PHONO JACK – for connection of your external PTT switch or PTT foot switch. This jack, as well as the PTT IN jack, may be separated and used for connection to an external sequencer. See the section titled PTT LOOP JUMPER - P5 later in this manual.

14 - PTT IN – RCA PHONO JACK – for connection of your external PTT switch or PTT foot switch. This jack, as well as the PTT OUT jack, may be separated and used for connection to an external sequencer. See the section titled PTT LOOP JUMPER - P5 later in this manual.

15 - MIC OUT – RJ45 MODULAR JACK – for connection to the Microphone connector on your radio. This connection is made using the included Mic Cable. (May be used as mic in for a radio with an RJ45 microphone connector.)

Note: References used throughout this document, such as **(R15)** refer to the *RIGblaster pro* Switch, Connector, Knob, Jack or LED as illustrated on these PANEL DESCRIPTION pages.

Example; “This connection is made to the MICROPHONE OUTPUT **(R15)** on the *RIGblaster pro*”. **(R15)** refers to Rear Panel illustration number 15 so you can quickly locate this particular Switch, Connector, Knob, Jack or LED.

INSTALLATION & CONNECTIONS

STEP 1 - INSTALL SOFTWARE AND START RECEIVING

You do not need the *RIGblaster pro* to receive so leave it in the box!

Insert our CD in your CD ROM drive. The West Mountain Radio screen will pop up in a few seconds.

From our screen click the “XMIT” button for the “West Mountain Radio RIGblaster Software Collection”.

Click the “XMIT” button for whatever mode you would like to try.

Click “XMIT” for whatever program you would like to try. Follow the installation prompts that appear on the screen to install the software.

Close the West Mountain Radio Window and put the West Mountain Radio CD in a safe place.

Your program is now installed. From Windows, click, “Start”, “Programs”, find your program icon and click to start that program.

Using one of the supplied mini plug cables, (referred to throughout this manual as “Patch Cord”) connect the speaker output of your radio to the Line In (Mic In on a laptop) of your computer. There are three other receive audio connection options that will be described later in this manual.

Tune in an appropriate signal for the mode you have selected. On our CD you will find a chart of standard operating frequencies for the various modes. So you can get a better understanding of what to listen for when tuning, our CD also contains recordings of many of these exciting new modes.

Double click the little yellow speaker icon in the lower right corner of your Windows screen. You will get your Windows sound playback control panel. Click “Options”, “Properties”, “Recording” and “OK” to get the recording control panel. With your mouse, turn up the “Line In” slider (or “Microphone In” on a laptop) about half way and “Select” that input.

Turn up your radio volume control (AF Gain) to the 9 or 10 o’clock position or until you see a signal displayed on the ham radio sound card software screen.

Follow the instructions or help that comes with the software to tune in the station using your radio and/or the software.

You should then be receiving that station. Try tuning in several other stations or even try another program or mode.

Before proceeding beyond this step, you should disconnect the audio cable installed above.

STEP 2 - INSTALL JUMPERS and CONNECT MIC CABLE

Jumpers are not installed as shipped; they are packed separately (see Items included with the *RIGblaster pro* on Page 3). To install jumpers, see MICROPHONE JUMPERING and SERIAL PORT & RIG CONTROL JUMPER DIAGRAMS in the back of this manual. These jumpers are necessary so the *RIGblaster pro* microphone pin assignments will match the different microphone pin assignments of various radio equipment manufacturers such as Icom, Yaesu, Kenwood, Alinco, TenTec, Elecraft, etc..

After you have installed the jumpers for your specific radio, connect the supplied Mic Cable in one of the following manners:

FOR RADIOS WITH A STANDARD 8 PIN SCREW ON MICROPHONE CONNECTOR

Using the supplied 3 foot mic cable connect the end with the RJ45 connector to MIC OUT (R15) on the rear of the *RIGblaster pro*. Connect the other end to the Mic Connector on your radio. Then plug your radio microphone into MICROPHONE CONNECTOR (F1) on the front panel of the *RIGblaster pro*.

FOR RADIOS WITH AN RJ45 MICROPHONE CONNECTOR

Using the supplied 3 foot mic cable connect the end with the RJ45 connector to Mic Connector on your radio. Connect the other end to the to MICROPHONE CONNECTOR (F1) on the front panel of the *RIGblaster pro*. Then plug your radio microphone into MIC OUT (R15) on the rear of the *RIGblaster pro*.

Make sure the *RIGblaster pro* Power Switch (F14) is turned off, then plug the wire from the Power Supply into the Power Jack (R1) on the rear panel of the *RIGblaster pro*. Plug in the Power Supply, turn off the *RIGblaster pro* Process Switch (F10) then turn on the *RIGblaster pro* Power Switch (F14). The Green “Power” LED (F15) and the Green “mic” LED (F8) should come on. The Green “level.” LED (F6) will come on briefly then will go off.

Confirm that EVERYTHING on your mic works correctly, including an on-the-air audio report. If your mic works perfectly, you have the jumpers installed correctly. If you have a problem, make sure you used the jumper diagram that matches your mic, not necessarily your radio. After market mics, especially Yaesu may not have exactly the same wiring as your original radio mic.

At this point, if and only if your mic works perfectly, continue to the next step.

STEP 3 - CONNECT SERIAL CABLE(s)

We suggest you read this step through entirely before doing it.

Turn off the *RIGblaster pro* Power Switch. The Green “Power” LED and the Green “mic” LED should go off.

Turn off your radio and your computer before connecting cables to either.

One DB9 Male to DB9 Female Serial Cable is supplied with the *RIGblaster pro*. The specific software and the manner in which you intend to operate the various functions facilitated by the *RIGblaster pro* will determine how you connect the serial cables.

To do basic SoundCard applications such as PSK31, SSTV, CW, RTTY, connect the supplied serial cable between an available serial port on your computer and SERIAL/COM RS232 IN/OUT A (R3) on the rear of the *RIGblaster pro*.

Read the section titled COM PORT & RIG CONTROL JUMPER DIAGRAMS to help you determine if you need to connect a second serial cable (not supplied) between a second serial port on your computer and SERIAL/COM RS232 IN/OUT B (R2) on the rear of the *RIGblaster pro*.

Additional DB9 to DB9 Serial Cables can be purchased from West Mountain Radio at www.westmountainradio.com.

Turn on the *RIGblaster pro* Power Switch. The Green “Power” LED and the Green “mic” LED should come on. The Green “level.” LED (F6) will come on briefly then will go off. At this time no other LED should light.

Boot the computer. During the boot process you should see the PTT LED (F11) blink on and off at least once. When the boot is complete the PTT LED should be off if not you have a software problem, see the Support pages of our Web Site. This test confirms that the cable, the computer serial port, and the PTT circuitry in the *RIGblaster pro* are working properly together. Also see our web site support page if you have Windows/ME. www.westmountainradio.com

Proceed to the next step of the installation if and only if this step checks out **OK**.

STEP 4 - CONNECT AUDIO CABLES

We suggest you read this step through entirely before performing it. This will give you a better understanding of what steps need to be done and what can be skipped.

Turn off the *RIGblaster pro* Power Switch. The Green “Power” LED and the Green “mic” LED should go off.

Turn off your radio and your computer before connecting cables to either unit.

Six 1/8 inch Stereo Mini Plug Patch Cords are supplied with the *RIGblaster pro*. Throughout this step these will be referred to as “Patch Cords”. What software and the manner in which you intend to operate the various functions facilitated by the *RIGblaster pro* will determine how many and where you connect these patch cords. Additional 1/8 inch Stereo Mini Plug Patch Cords can be purchased from West Mountain Radio www.westmountainradio.com.

We highly recommend that you attach Patch Cord Labels to each end of the Patch Cords before installing them.

ROUTING: TRANSMIT COMPUTER AUDIO → *RIGblaster pro* → Computer Speakers

For Desktop Computers, unplug the computer speakers from the computer and plug them into SPKR OUT (R8) on the rear of the *RIGblaster pro*. Then plug one end of a patch cord to the jack on the computer where the computer speakers were plugged. Plug the other end of that patch cord to LINE IN (R9) on the rear of the *RIGblaster pro*.

For laptop computers with only two audio jacks, plug one end of a patch cord to the headphone jack on the laptop computer and plug the other end of that patch cord to LINE IN (R9) on the rear of the *RIGblaster pro*.

ROUTING: RECEIVE RADIO AUDIO → *RIGblaster pro* → Computer Sound, Line In

Three methods are available for getting audio from your radio to your computer. The method you use depends primarily on the options available on your radio. If your radio has the provision for connecting an external speaker but no other means of getting audio out of the radio, then Method 1 should be used. If your radio has fixed level audio available from the rear panel via an accessory socket, then Method 2 is recommended. If your radio has output audio available at the mic connector, *RIGblaster pro* has the capability to use this as a source for audio input to the computer and this will be Method 3. In all three methods, *RIGblaster pro* will provide DC isolation for receive audio between the radio and the computer.

Method 1:

For this method, you will need an external speaker for your radio.

Plug one end of a patch cord to the External Speaker Output jack of your radio and the other end to AUDIO IN (R11) on the rear panel of the *RIGblaster pro*. Then plug your radio external speaker into SPKR OUT (R12) on the rear panel of the *RIGblaster pro*.

Plug one end of a patch cord to LINE OUT (R10) on the rear panel of the *RIGblaster pro* and plug the other end to Line In on your computer sound.

Method 2:

For this step you will need a special cable. One end of this cable will have a mini plug which is the same as those provided on the ends of the patch cords supplied with your *RIGblaster pro*. The other end will be a connector that will plug into the source of fixed level audio on your radio. This may be labeled “Data Out, Monitor Out, Record Out, Patch Out, etc. and it could be a din plug, a mini din plug, an RCA plug, etc. Consult your radio Owners Manual for the required connector. West Mountain Radio has several cables available for this purpose as *RIGblaster* optional Accessories for Icom, Kenwood and Yaesu radios. See www.westmountainradio.com.

Plug the mini plug end of this cable to AUDIO IN (R11) on the rear panel of the *RIGblaster pro*. Plug the other end of this cable to the connector on your radio that provides fixed level audio as outlined in the previous paragraph.

Plug one end of a patch cord to LINE OUT (R10) on the rear panel of the *RIGblaster pro* and plug the other end to Line In on your computer sound.

Using this method, Method 2, there will be no connection to SPKR OUT (R12) on the rear of the *RIGblaster pro*.

Method 3:

Using this method audio is supplied to the *RIGblaster pro* through the Mic Cable previously installed in Step 1 above. On some radios output audio is available on a radio mic connector pin and therefore can be obtained with jumpering on the P1 jumper block inside the *RIGblaster pro*. See the example under “MICROPHONE PIN ASSIGNMENTS (example)” later in this manual. Consult the microphone pin assignment diagram in the Owners manual of your radio to determine which pin on the mic connector and thus which pin on the P1 jumper block to jumper to RCV AUD and RCV AUD GND.

In the Microphone Pin Assignments example later in this manual, an IC-756PRO, is shown. On the IC-756PRO, pin 8 is used for receive audio and thus Pin 8 is jumpered to RCV AUD on the OUTPUT side of the P1 jumper block to provide receive audio to the *RIGblaster pro* Ground reference must also be provided by jumpering RCV AUD GND on the INPUT side to GNDTIE on the INPUT side also on the P1 jumper block. On Icom radios this audio is not fixed, it is variable with the AF Gain control.

After completing the necessary jumpering on the P1 jumper block, plug one end of a patch cord to LINE OUT (R10) on the rear panel of the *RIGblaster pro* and plug the other end to Line In on your computer sound.

STEP 5 - SET AUDIO LEVELS

For the first part of this procedure leave your Radio turned OFF.

Open your Windows sound control panel (double click on the little yellow speaker icon in the task bar) and un-mute the “wave” output and the left hand “Volume Control” output. Set the virtual “Volume” and “Wave” sliders to a position one notch down from the top. Also set the virtual balance sliders to the center.

If your computer speakers are hooked up and they have a volume control knob, turn that knob most of the way, but not all the way, down. If they do not have a volume knob, they may be too loud and you will want to turn them off after you are sure that you can turn your sound card up high enough for them to be uncomfortably loud.

Make sure the *RIGblaster pro* is turned ON, the “process” Switch (F10) is off and the “level set” Knob (F5) is all the way Counterclockwise. Set your software to Transmit or Tune. The *RIGblaster pro* “c.s.” LED (F7) and “ptt” LED (F11) should be on. If you are using software, such as WinPSK, that brings up both RTS and DTR when set to transmit the CW LED (F12) may also come on. If these LEDs do not come on, recheck the serial port software setting for PTT control. In the *RIGblaster pro*, PTT is always controlled with the RTS. If the “c.s.” and “ptt” LEDs are on, then the “level” LED (F6) should also be ON indicating there is sufficient audio from the sound output of your computer being delivered to the *RIGblaster pro* to adequately modulate your radio. At this point, you can refine the wave output setting on the Windows sound control panel to the point just past where the “level” LED has just come on. Set the software back to Receive.

Turn ON your Radio for the remainder of this procedure.

For SSB Radios use your normal mic gain setting, turn your speech compressor off and set the transmitter RF drive (power control) all the way up. You will want to use a dummy load for this procedure. If you are using PSK software make sure that the transmit audio is between 500Hz and 2500 Hz, otherwise you may be outside the limits of the response of your radio and you may not be able to transmit properly. Set your software to Transmit or Tune. Then slowly turn up the “level set” Knob (F5) on the front of the *RIGblaster pro* to the point where your ALC just starts to move or you have achieved your normal RF power output.

Your final setting must produce less than full RF power output from your radio.

Warning: you should not exceed the AM, FM or RTTY power rating of your radio. After this setting is completed, check to make sure your ALC meter is below limiting. Even if your radio is rated at full output and continuous duty, do not set the audio to full output!

Note that if you run your computer sound output at maximum or close to maximum, and the *RIGblaster pro* “level set” turned way down, you may have distortion from your computer sound and a poor quality signal. Generally the wav and volume sliders should be between 1/3 and 2/3 open and the *RIGblaster pro* “level set” Knob should be between 1/8 and 7/8 open.

With an FM rig you must set the audio level with the “level set” Knob using a deviation meter or by comparing the level of your transmit audio to other stations using another radio.

For a more information about Computer Sound Cards, see the article titled “The In’s and Out’s of a Sound Card” in October 2003 QST. Also available in PDF format on our Web Site at:

<http://www.westmountainradio.com/pdf/Ins&Outs.pdf>

STEP 6 - CW CABLING AND SETUP

Turn off both your radio and the *RIGblaster pro* before connecting cables to either unit.

Plug one end of a patch cord to the CW OUT (R5) jack on the rear panel of the *RIGblaster pro*. Plug the other end into the CW Key jack on your radio. If the CW Key jack on your radio is a ¼” jack, it will be necessary to use the supplied 1/8” to ¼” adapter.

For computer CW it is necessary to make sure your radio CW keying is set for “Straight Key” mode for the jack you are using. The remaining setup for computer controlled CW will be done in the application software you choose. Control of CW is not selectable and will always be done through Serial/Com RS232 In/Out A, with the DTR line. Make sure when you configure your software that you observe this convention.

On the CW OUT (R5) jack, the sleeve goes to common ground and the tip goes to the keying circuit, the ring of this connector is not used.

STEP 7 - FSK CABLING AND SETUP

Turn off both your radio and the *RIGblaster pro* before connecting cables to either unit.

Your radio will have to be capable of FSK / RTTY to utilize this option. FSK wiring is unique to each Amateur Radio transceiver manufacturer. Therefore you will have to consult your specific radio Owners Manual for information as to how to connect to the FSK input of your radio.

For many radios, the FSK connection is via an accessory connection on the rear panel of the transceiver. West Mountain Radio has a readymade cable for connection between a RIGblaster and the FSK input of many Icom, Kenwood and Yaesu radios. They are available on our web site <http://www.westmountainradio.com> under RIGblaster Accessories.

After you have constructed or purchased the correct FSK cable, connect the mini plug end to FSK OUT (R6) on the rear panel of the *RIGblaster pro*. Connect the other end of this cable to the appropriate connection on your transceiver. Always check the wiring prior to connecting homemade cables to your equipment.

On the FSK OUT (R6) jack, the sleeve goes to common ground and the tip goes to the FSK keying circuit, the ring of this connector is not used.

Make any necessary jumpering on the P16 jumper block as described later in this manual under COM PORT & RIG CONTROL JUMPER DIAGRAMS.

In most cases you will have to operate your radio in RTTY mode to enable FSK input.

STEP 8 - RIG CONTROL CABLING AND SETUP

RIG Control cabling and jumpering differs depending on the radio manufacturer.

Most ICOM and TenTec (with CI-V) use a single bi-directional conductor and thus require one of our standard patch cords to connect the *RIGblaster pro* and the radio. To cable an ICOM or TenTec (with CI-V) radio to a *RIGblaster pro*, connect one end of a patch cord to CTL IN/OUT (R4) on the rear of the *RIGblaster pro*. Connect the other end to the "CI-V REMOTE CONTROL JACK" on the rear of your ICOM or TenTec radio. The factory setting of jumpering on the P16 Jumper Block is already set for ICOM/TenTec Rig Control through SERIAL/COM RS232 IN/OUT A.

Specific jumpering on the P16 jumper block inside the *RIGblaster pro* is required for ICOM, TenTec, or Yaesu radios. When jumpered for ICOM radios, both transmitted and received data are on the tip in relation to the sleeve and there is no connection to the ring. When jumpered for Yaesu, received data from the radio is on the tip and transmitted data to the radio is on the ring, both are in relation to ground on the sleeve. See COM PORT & RIG CONTROL JUMPER DIAGRAMS later in this manual for additional information about Rig Control.

With a Yaesu it is a little more complicated. The Yaesu CAT system uses three wires and they have different connectors and pin wiring arrangements between different models. Older Yaesu radios require the rig control TTL (5 volt) to RS232 level converter built into the *RIGblaster pro*.

For an older Yaesu CAT system you must set the *RIGblaster pro* rig control jumper P16 to Yaesu. You must also change the plug on one end of a patch cord to match the Yaesu DIN jack. You must make sure that the tip of our plug comes from the data out of your radio and the Ring goes to the data in to your radio.

Older Kenwood radios that have provisions for TTL control are not possible to control with a *RIGblaster pro*. These Kenwood radios utilize what is referred to as Negative Logic and are not compatible with the Positive Logic employed in the *RIGblaster pro* TTL to RS232 converter. Positive logic, as employed in most computer interface circuitry, represents a logical one with a positive voltage and a logical zero with a zero voltage.

To connect a *RIGblaster pro* to Yaesu radios with a 6 pin DIN receptacle with TTL level CAT control, the following cable would have to be constructed. We have found pin numbers vary from Yaesu model to model but GND is usually numbered pin 1.

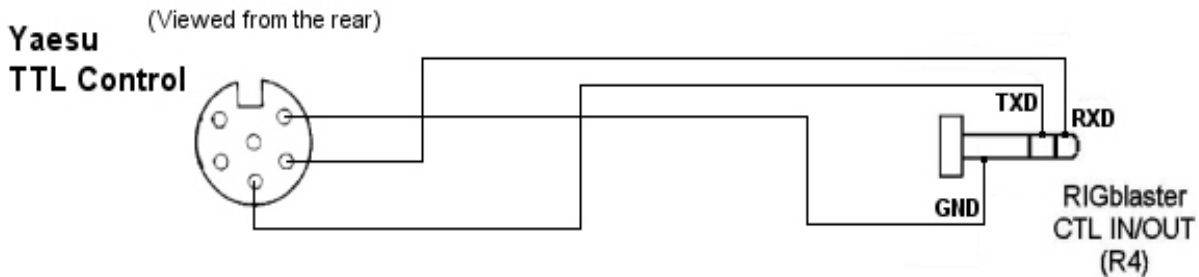

If you have a Yaesu or other brand of radio with an RS232 Rig/CAT control jack you should not use our rig control output. You may use the *RIGblaster pro*'s RXD & TXD on A passed through to B option (#9 on the P16 Jumper block). This will allow both sound card operation, PTT, CW and rig control with a single serial port with software such as HamScope, MixW or WriteLog. If you wish to use separate sound card and rig control programs at the same time you will have to make a direct connection from your computer to the radio's RS232 control jack. If the radio is equipped with a FEMALE DB-9 RS232 connector for Computer Control (CAT), the following cable will be necessary from the B Port on the *RIGblaster pro* to the radio RS232 DB-9. Both DB-9 connectors shown here are MALE connectors.

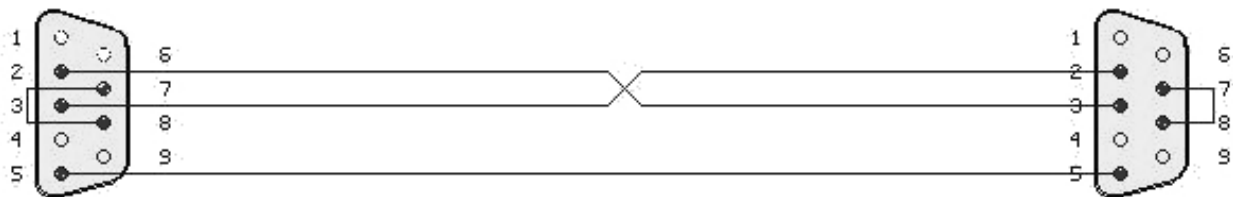

If you have a newer Kenwood (Example TS-570/870/2000) radio or an Icom IC-7800 with a MALE RS232 CAT/Rig Control jack you should not use the CTL IN/OUT jack on the *RIGblaster pro*. You may use the *RIGblaster pro* for both sound card operation, PTT, CW and Rig Control with a single serial port using software such as HamScope, MixW, WriteLog, etc.. For these radios you should use our Optional DB9M to DB9F Serial/Extension Cable or equivalent connected from the B Port of the *RIGblaster pro* to the radio's MALE RS232 DB-9 CAT/Rig Control connector. The wiring on this cable is straight through. You should not use a cable with TXD and RXD crossed over commonly referred to as a "Null Modem Cable".

STEP 9 - ADVANCED AUDIO PROCESSING CONSIDERATIONS

A unique feature of the *RIGblaster pro* is that you may process, equalize, compress or expand transmitted audio. This is done simply by routing your microphone audio into your computer and back out to your radio while processing the audio (real time) with appropriate sound card software.

To enable this feature and the ability to make digital recordings of your station operation, you must plug the jumper on the P6 Jumper Block to send your microphone audio to the computer. See the section labeled “MIC MODE JUMPER – P6” later in this manual for jumpering diagrams. You must also connect a cable from the *RIGblaster pro* MIC OUT (R7) to your Computer Sound Card MIC IN to enable this feature.

Your computer must have an available Mic In and you must have a full duplex sound card that will pass the sound card microphone input through software and then back out to the *RIGblaster pro*.

To enable microphone audio processing you must turn on the “process” switch (F10). The function of process mode is to redirect audio from your radio microphone through the computer and back to the radio.

To utilize Process Mode of the *RIGblaster pro* to process the audio from your radio microphone you must run appropriate real time equalization software on your computer and set your sound card recording control panel to feed microphone audio through the software and your sound card playback control panel to send the audio back in to the radio through the *RIGblaster pro*. Note that this is a different sound card setup than is used by digital mode sound card programs. You should also note that if the sound card is set incorrectly you might have feedback and/or echo conditions. You will not hear your voice coming from the computer speakers as they are muted on transmit in the process mode to prevent acoustic feedback.

You will have to set the gain of the sound card input and output for minimum distortion and minimum noise by experimentally determining the optimum settings for your equipment. Do the basic setup with the equalizer software set to “flat”. Once you have satisfied yourself that your microphone is being passed through the computer with little or no change you may then experiment with equalization of your microphone audio.

You will find that only the equalization control in the voice spectrum of 100 to 3500 Hz will have a noticeable effect on your voice. Trying to boost equalization outside of this spectrum may overdrive your sound card or radio audio stages with microphone handling and room noises. It is generally desirable to totally cut or filter out the frequencies outside the voice spectrum range. You should consider that equalization can be done in any way to make your audio sound either better or worse. You should try to achieve the most intelligible audio for DXing and general communication. For wideband FM or AM operation you may want the most natural audio for a high fidelity sound.

If you run compression or noise reduction software all of the same issues of doing equalization are present.

STATION HOOKUP DIAGRAM (basic sound card function)

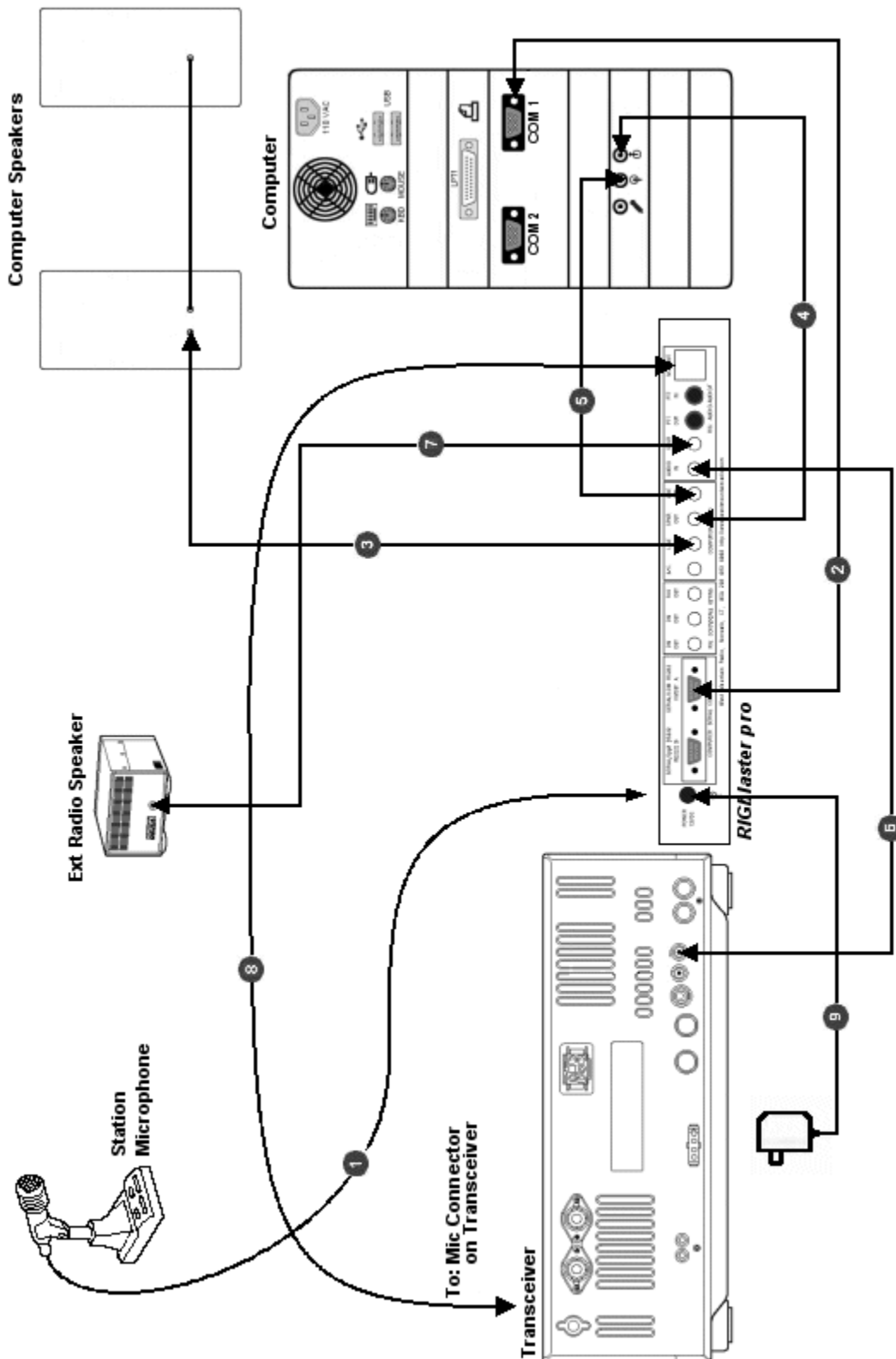

See next page for a description of each numbered wire on this diagram.

The diagram on the preceding page shows a *RIGblaster pro* integrated into an Amateur Radio Station consisting of a Professional Quality Transceiver and a Desktop Computer with a Serial Port and a Sound Card. With appropriate software, it enables most Amateur Radio Sound Card Software.

For each numbered wire there is a description of its function and the end points to which it connects.

- ① - The station microphone is connected to the Microphone Connector (F1) on the front of the *RIGblaster pro*.
- ② - This cable is a DB9M to DB9F Serial Cable (supplied with *RIGblaster pro*) It connects the *RIGblaster pro* SERIAL/COM RS232 IN/OUT A (R3) port to the Computer serial port. It is used for one and only one of the following combinations of function:

PTT Control, CW Keying and Rig Control
PTT Control, CW Keying and FSK Keying
- ③ - This wire connects the Computer Speakers to the *RIGblaster pro*. One end plugs into the SPKR OUT (R8) jack on the rear of the *RIGblaster pro*. The other end remains as it was before, that is, connected to the Computer Speakers.
- ④ - This is a mini plug Patch Cord that connects the Computer Sound Card - Line Out to the *RIGblaster pro*. One end plugs into the LINE IN (R9) jack on the rear of the *RIGblaster pro*. The other end plugs into the Line Out jack on the Computer Sound Card.
- ⑤ - This is a mini plug Patch Cord that connects the Computer Sound Card - Line In to the *RIGblaster pro*. One end plugs into the LINE OUT (R10) jack on the rear of the *RIGblaster pro*. The other end plugs into the Line In jack on the Computer Sound Card.
- ⑥ - This is a mini plug Patch Cord that routes receive audio from the Radio to the *RIGblaster pro*. It provides a path for audio from the radio to the computer. One end plugs into the AUDIO IN (R11) jack on the rear of the *RIGblaster pro*. The other end plugs into the EXTERNAL SPEAKER JACK on the transceiver.
- ⑦ - This wire connects the Radio External Speaker to the *RIGblaster pro*. One end plugs into the SPKR OUT (R12) jack on the rear of the *RIGblaster pro*. The other end remains as it was before, that is, connected to the Radio External Speaker.
- ⑧ - This is the Microphone Cable (supplied with the *RIGblaster pro*) that connects the *RIGblaster pro* to the Microphone Input jack of the transceiver. The end with the RJ45 connector plugs into the MIC OUT (R15) jack on the rear of the *RIGblaster pro*. The end with the standard 8-pin Screw on Mic Connector plugs into the MICROPHONE CONNECTOR on the transceiver.
- ⑨ - This wire, from the Power Supply (supplied with the *RIGblaster pro*), provides power for the *RIGblaster pro*. It plugs into the POWER 12VDC (R1) jack on the rear of the *RIGblaster pro*.

STATION HOOKUP DIAGRAM (all features & functions)

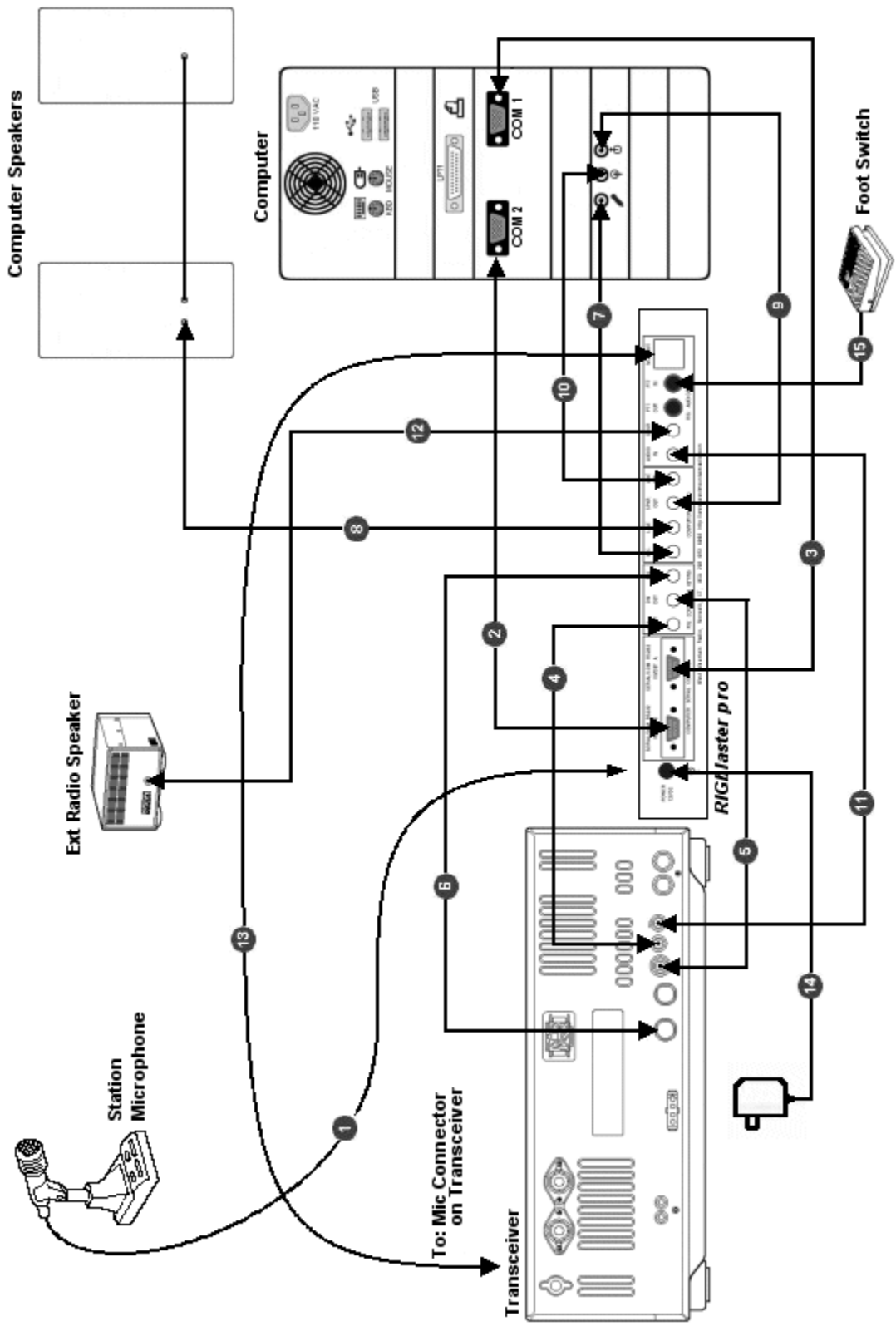

EA

See next page for a description of each numbered wire on this diagram.

The diagram on the preceding page shows a *RIGblaster pro* integrated into an Amateur Radio Station consisting of a Professional Quality Transceiver and a Desktop Computer with two Serial Ports and a standard Sound Card. With appropriate software, it enables every function possible with a *RIGblaster pro*.

For each numbered wire there is a description of its function and the end points to which it connects.

① - The station microphone is connected to the Microphone Connector (F1) on the front of the *RIGblaster pro*.

② - This cable is an optional DB9M to DB9F Serial Cable (not supplied) and connects the *RIGblaster pro* SERIAL/COM RS232 IN/OUT B (R2) port to the Computer secondary serial port. It is used for one and only one of the following functions:

FSK keying (if SERIAL/COM RS232 IN/OUT A is being used for Rig Control)

Rig Control (if SERIAL/COM RS232 IN/OUT A is being used for FSK)

Rig Control pass through from SERIAL/COM RS232 IN/OUT A (only if your radio has a DB9 Rig Control jack and you wish to use a program like HamScope or MixW that does Rig Control, CW, and PTT)

③ - This cable is a DB9M to DB9F Serial Cable (supplied with *RIGblaster pro*) It connects the *RIGblaster pro* SERIAL/COM RS232 IN/OUT A (R3) port to the Computer primary serial port. It is used for one and only one of the following combinations of function:

PTT Control, CW Keying and Rig Control

PTT Control, CW Keying and FSK Keying

④ - This is a mini plug Patch Cord that is used to interface the *RIGblaster pro* to the Radio for Rig Control. One end plugs into the CTL IN/OUT (R4) jack on the rear of the *RIGblaster pro*. The other end plugs into the CI-V REMOTE CONTROL jack on the rear of the transceiver. For CAT control with a Yaesu TTL jack, you will have to supply the plug on the other end and change the jumpering on the P16 Jumper Block. See the section titled “COM PORT & RIG CONTROL JUMPER DIAGRAMS (P16) later in this manual.

⑤ - This is a mini plug Patch Cord that is used to interface the *RIGblaster pro* to the radio enabling the Computer to key the Radio in CW mode. One end plugs into the CW OUT (R5) jack on the rear of the *RIGblaster pro*. The other end plugs into the STRAIGHT KEY JACK on the rear of the transceiver.

⑥ - This is an optional Cable that is used to interface the *RIGblaster pro* to the radio enabling the Computer to (FSK) key the Radio in RTTY mode. One end plugs into the FSK OUT (R6) jack on the rear of the *RIGblaster pro*. The other end connects to the FSK keying input on the transceiver. For many Icom radios, this cable is available from West Mountain Radio as a *RIGblaster* Accessory.

⑦ - This is a mini plug Patch Cord that is used to create the path for connecting the existing station microphone to the Computer Sound Card Mic In. One end plugs into the MIC OUT (R7) jack on the rear of the *RIGblaster pro*. The other end plugs into the Mic In jack on the Computer Sound Card. See the section “MIC MODE JUMPER – P6” later in this manual and STEP 9 -

ADVANCED AUDIO PROCESSING CONSIDERATIONS, earlier in this manual, for more information on using your radio mic on your computer.

⑧ - This wire connects the Computer Speakers to the *RIGblaster pro*. One end plugs into the SPKR OUT (R8) jack on the rear of the *RIGblaster pro*. The other end remains as it was before, that is, connected to the Computer Speakers.

⑨ - This is a mini plug Patch Cord that connects the Computer Sound Card - Line Out to the *RIGblaster pro*. One end plugs into the LINE IN (R9) jack on the rear of the *RIGblaster pro*. The other end plugs into the Line Out jack on the Computer Sound Card.

⑩ - This is a mini plug Patch Cord that connects the Computer Sound Card - Line In to the *RIGblaster pro*. One end plugs into the LINE OUT (R10) jack on the rear of the *RIGblaster pro*. The other end plugs into the Line In jack on the Computer Sound Card.

⑪ - This is a mini plug Patch Cord that routes receive audio from the Radio to the *RIGblaster pro*. It provides half the path for DC isolated audio from the radio to the computer. One end plugs into the AUDIO IN (R11) jack on the rear of the *RIGblaster pro*. The other end plugs into the EXTERNAL SPEAKER JACK [EXT SP] on the transceiver.

⑫ - This wire connects the Radio External Speaker to the *RIGblaster pro*. One end plugs into the SPKR OUT (R12) jack on the rear of the *RIGblaster pro*. The other end remains as it was before, that is, connected to the Radio External Speaker.

⑬ - This is the Microphone Cable (supplied with the *RIGblaster pro*) that connects the *RIGblaster pro* to the Microphone Input jack of the transceiver. The end with the RJ45 connector plugs into the MIC OUT (R15) jack on the rear of the *RIGblaster pro*. The end with the standard 8-pin Screw on Mic Connector plugs into the MICROPHONE CONNECTOR [MIC] jack on the transceiver.

⑭ - This wire, from the Power Supply (supplied with the *RIGblaster pro*), provides power for the *RIGblaster pro*. It plugs into the POWER 12VDC (R1) jack on the rear of the *RIGblaster pro*.

⑮ - This wire connects an existing PTT Foot Switch to the *RIGblaster pro*. It plugs into the PTT IN- RCA Phono Jack (R14) on the rear of the *RIGblaster pro*.

MICROPHONE JUMPER DIAGRAMS

8 PIN SCREW ON MICROPHONE JUMPERING

ALINCO, KENWOOD, SGC and ELECRAFT with 8 Pin Screw on Microphone Connectors

INPUT SIDE	
Pin #	
1	White Jumper to MIC – INPUT Side
2	White Jumper to PTT – INPUT Side
3	Blue Shunt Jumper to Pin 3 - OUTPUT Side
4	Blue Shunt Jumper to Pin 4 - OUTPUT Side
5	Blue Shunt Jumper to Pin 5 - OUTPUT Side
6	Blue Shunt Jumper to Pin 6 - OUTPUT Side
7	White Jumper to MIC GND – INPUT Side
8	White Jumper to PTT GND – INPUT Side
OUTPUT SIDE	
Pin #	
1	White Jumper to MIC – OUTPUT Side
2	White Jumper to PTT – OUTPUT Side
7	White Jumper to MIC GND – OUTPUT Side
8	White Jumper to PTT GND – OUTPUT Side

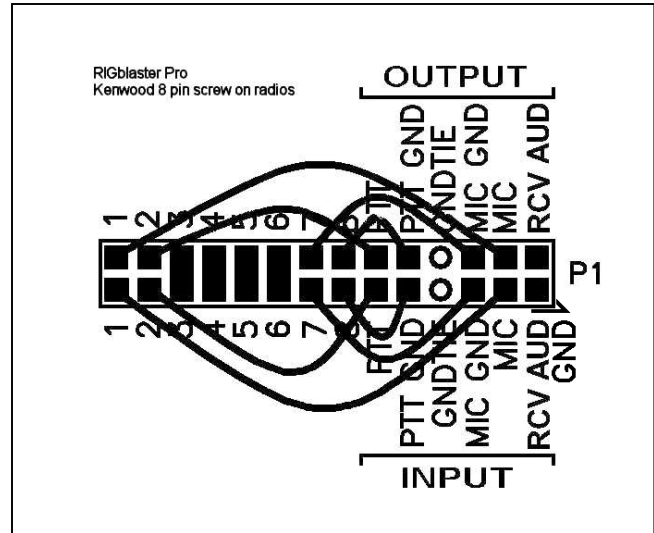

ICOM with 8 Pin Screw on Microphone Connectors

INPUT SIDE	
Pin#	
1	White Jumper to MIC – INPUT Side
2	Blue Shunt Jumper to Pin 2 - OUTPUT Side
3	Blue Shunt Jumper to Pin 3 - OUTPUT Side
4	Blue Shunt Jumper to Pin 4 - OUTPUT Side
5	White Jumper to PTT – INPUT Side
6	White Jumper to PTT GND – INPUT Side
7	White Jumper to MIC GND – INPUT Side
8	Blue Shunt Jumper to Pin 8 - OUTPUT Side
OUTPUT SIDE	
Pin #	
1	White Jumper to MIC – OUTPUT Side
5	White Jumper to PTT – OUTPUT Side
6	White Jumper to PTT GND – OUTPUT Side
7	White Jumper to MIC GND – OUTPUT Side

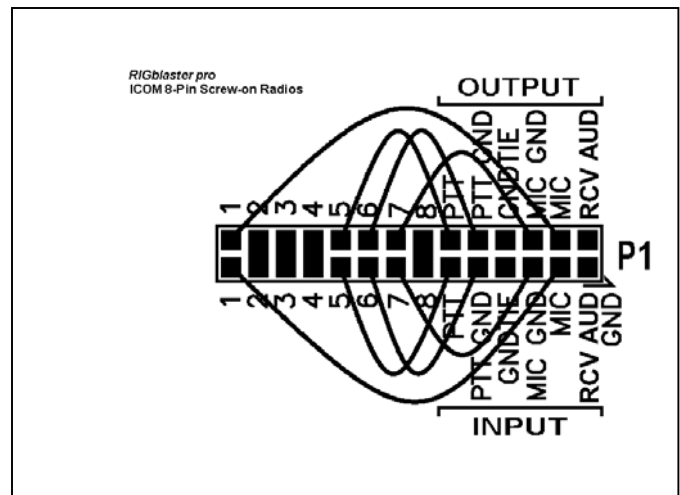

YAESU with 8 Pin Screw on Microphone Connectors

(This jumpering is for older Yaesu radios with Microphones that have common PTT & audio ground and older hand mics, desk mics and Heil mics)

INPUT SIDE		
Pin #		
1	Blue Shunt Jumper to	Pin 1 - OUTPUT Side
2	Blue Shunt Jumper to	Pin 2 - OUTPUT Side
3	Blue Shunt Jumper to	Pin 3 - OUTPUT Side
4	Blue Shunt Jumper to	Pin 4 - OUTPUT Side
5	Blue Shunt Jumper to	Pin 5 - OUTPUT Side
6	White Jumper to	PTT - INPUT Side
7	White Jumper to	PTT GND - INPUT Side
8	White Jumper to	MIC - INPUT Side
	GND TIE White Jumper to	GND TIE - OUTPUT Side
OUTPUT SIDE		
Pin #		
6	White Jumper to	PTT - OUTPUT Side
7	White Jumper to	PTT GND - OUTPUT Side
8	White Jumper to	MIC - OUTPUT Side

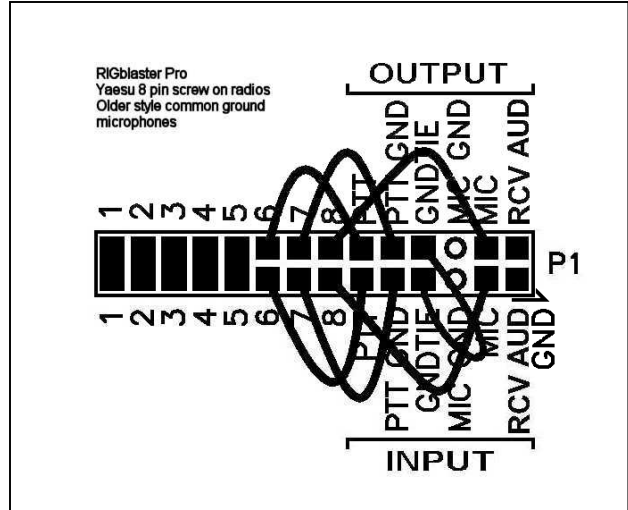

YAESU with 8 Pin Screw on Microphone Connectors

(This jumpering is for newer Yaesu radios that have Microphones with isolated PTT & audio grounds.)

JRC JST245 with 8 Pin Screw on Microphone Connectors

INPUT SIDE		
Pin #		
1	Blue Shunt Jumper to	Pin 1 OUTPUT Side
2	Blue Shunt Jumper to	Pin 2 OUTPUT Side
3	Blue Shunt Jumper to	Pin 3 OUTPUT Side
4	Blue Shunt Jumper to	Pin 4 OUTPUT Side
5	White Jumper to	PTT GND - INPUT Side
6	White Jumper to	PTT - INPUT Side
7	White Jumper to	MIC GND - INPUT Side
8	White Jumper to	MIC - INPUT Side
OUTPUT SIDE		
Pin #		
5	White Jumper to	PTT GND - OUTPUT Side
6	White Jumper to	PTT - OUTPUT Side
7	White Jumper to	MIC GND - OUTPUT Side
8	White Jumper to	MIC - OUTPUT Side

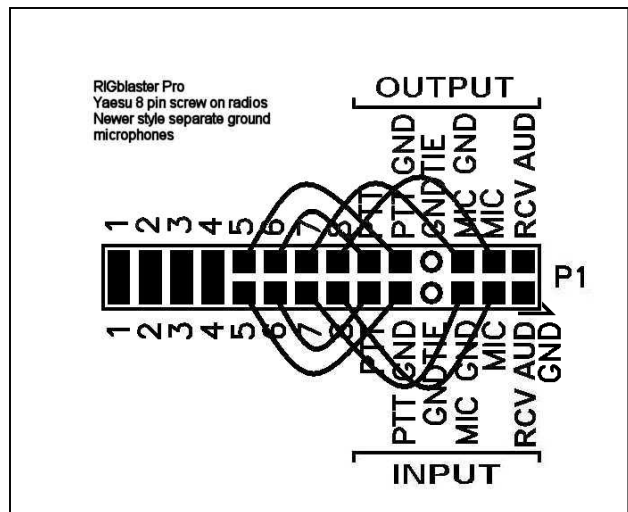

RJ45 MODULAR STYLE MICROPHONE JUMPERING

Plug your RJ45 mic. in the back “mic out” (R16) jack of the *RIGblaster pro*. Using the supplied mic. Cable, screw the 8 pin plug in the front MICROPHONE CONNECTOR (F1) of the *RIGblaster pro* and plug the RJ45 end into your radio RJ45 mic jack. Be sure to use the correct jumpering for your radio as follows and observe that PTT & MIC are crisscrossed INPUT to OUTPUT.

ICOM with RJ45 Microphone Connectors

(This jumpering is for Icom 706 (all versions) and most, but not all ICOM FM rigs)

INPUT SIDE		
Pin #		
1	Blue Shunt Jumper to	Pin 1 - OUTPUT Side
2	White Jumper to	PTT GND – INPUT Side
3	White Jumper to	MIC - OUTPUT Side *
4	White Jumper to	MIC GND – INPUT Side
5	White Jumper to	PTT - OUTPUT Side *
6	Blue Shunt Jumper to	Pin 6 - OUTPUT Side
7	Blue Shunt Jumper to	Pin 7 - OUTPUT Side
8	Blue Shunt Jumper to	Pin 8 - OUTPUT Side
OUTPUT SIDE		
Pin #		
2	White Jumper to	PTT GND – OUTPUT Side
3	White Jumper to	MIC - INPUT Side *
4	White Jumper to	MIC GND – OUTPUT Side
5	White Jumper to	PTT - INPUT Side *

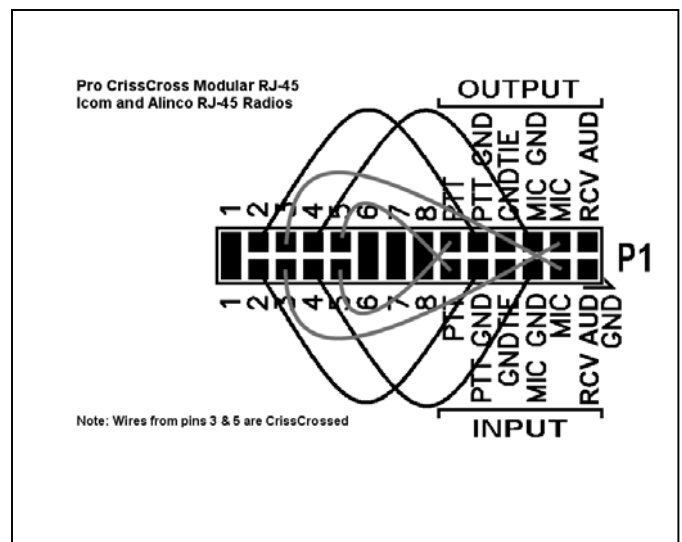

KENWOOD with RJ45 Microphone Connectors and most, but not all Kenwood FM rigs

INPUT SIDE		
Pin #		
1	Blue Shunt Jumper to	Pin 1 - OUTPUT Side
2	Blue Shunt Jumper to	Pin 2 - OUTPUT Side
3	White Jumper to	PTT GND – INPUT Side
4	White Jumper to	PTT - OUTPUT Side *
5	White Jumper to	MIC GND – INPUT Side
6	White Jumper to	MIC - OUTPUT Side *
7	Blue Shunt Jumper to	Pin 7 - OUTPUT Side
8	Blue Shunt Jumper to	Pin 8 - OUTPUT Side
OUTPUT SIDE		
Pin #		
3	White Jumper to	PTT GND – OUTPUT Side
4	White Jumper to	PTT - INPUT Side *
5	White Jumper to	MIC GND – OUTPUT Side
6	White Jumper to	MIC - INPUT Side *

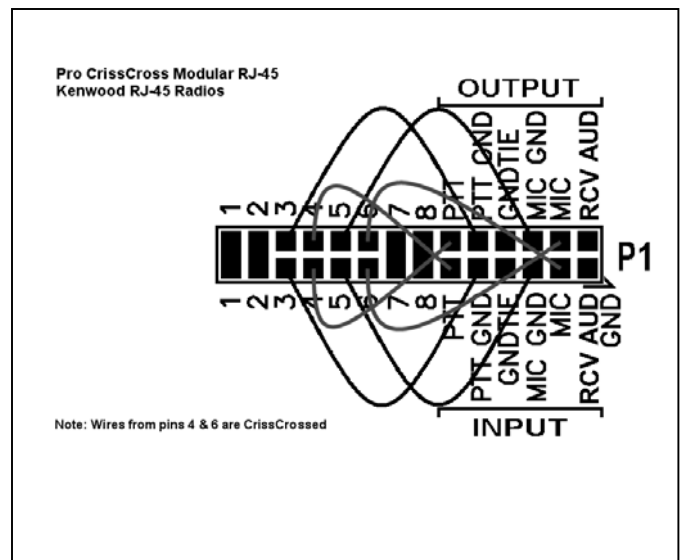

YAESU with RJ45 Microphone Connectors and most, but not all Yaesu FM rigs

	INPUT SIDE	
Pin #		
1	Blue Shunt Jumper to	Pin 1 - OUTPUT Side
2	White Jumper to	PTT GND – INPUT Side
3	White Jumper to	PTT - OUTPUT Side *
4	White Jumper to	MIC - OUTPUT Side *
5	White Jumper to	MIC GND – INPUT Side
6	Blue Shunt Jumper to	Pin 2 - OUTPUT Side
7	Blue Shunt Jumper to	Pin 7 - OUTPUT Side
8	Blue Shunt Jumper to	Pin 8 - OUTPUT Side
	OUTPUT SIDE	
Pin #		
2	White Jumper to	PTT GND – OUTPUT Side
3	White Jumper to	PTT - INPUT Side *
4	White Jumper to	MIC - INPUT Side *
5	White Jumper to	MIC GND – OUTPUT Side

* - Crisscrossed White Jumper

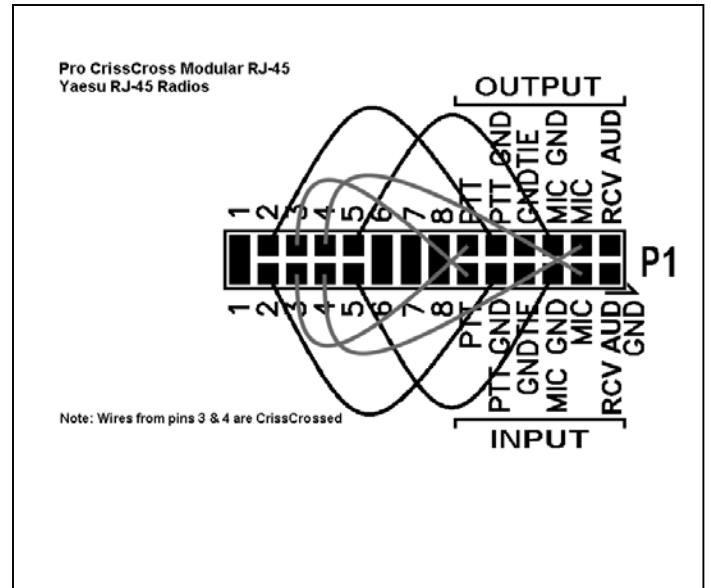

RECEIVE AUDIO AVAILABLE ON THE MIC CONNECTOR

On some radios output audio is available on a mic connector pin and therefore can be obtained with jumpering on the P1 jumper block inside the *RIGblaster pro*. Consult the microphone pin assignment diagram in the Owners manual of your radio to determine which pin on the mic connector and thus which pin on the P1 jumper block to jumper to RCV AUD.

See the section titled “RECEIVE AUDIO FROM YOUR RADIO (3 WAYS)” for the different methods of getting audio from your radio to the computer Sound Card.

HOW WE CREATED OUR JUMPERING DIAGRAMS

The jumper diagrams and charts in the back of this manual should be checked against the actual microphone pin assignment diagram as shown in your radio Owners Manual.

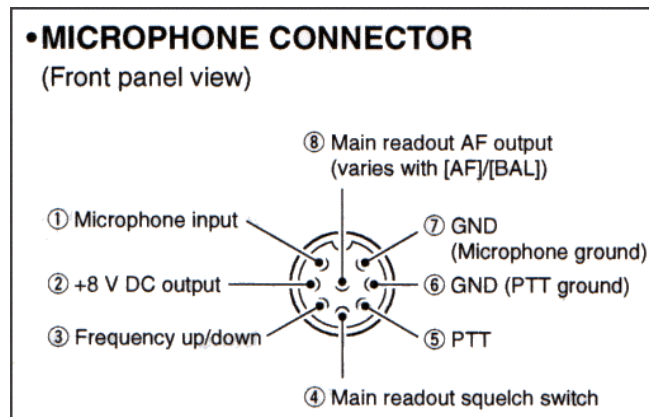

Shown above is such a diagram from a typical Amateur Radio transceiver.

If we were to create a microphone jumpering diagram for the P1 jumper block inside the *RIGblaster pro* for this radio, it would be done as follows:

Microphone input is jumpered from pin 1 to MIC

PTT is jumpered from pin 5 to PTT

GND (PTT Ground) is jumpered from pin 6 to PTT GND

GND (Microphone ground) is jumpered from pin 7 to MIC GND

The remaining 4 pins are not needed by the *RIGblaster pro*, but must be jumpered straight across by using a Blue Shunt Jumper. These Direct Blue Shunt Jumpers are necessary so all other functions of the microphone are passed through to the radio and voltage from the radio is available to the microphone with the microphone plugged into the *RIGblaster pro*.

All the jumper diagrams in this manual were developed in this manner.

If a radio is manufactured and the manufacturer does not publish a microphone pin assignment diagram, it is not possible to create a jumper diagram for the *RIGblaster pro*.

MIC MODE JUMPER – P6

The MIC MODE JUMPER is located on the P6 jumper block and is used to optionally route the radio microphone that is connected to the *RIGblaster pro* on to the computer sound Mic In connection and to either provide for bias in the case of electret microphones or no bias in the case of dynamic microphones. The default (as shipped from the factory) is with this jumper set to disable Radio mic out to computer mic in. There are three possible settings for this jumper as follows:



P6

**MIC OUT to Computer Disabled
(Factory Default)**



P6

**MIC OUT to Computer Enabled,
needed for electret mics but will work
with either dynamic or electret mics**



P6

**MIC OUT to Computer Enabled,
for dynamic mics that do NOT need bias
(NOT for ICOM mics)**

When the “mic” LED is on, your microphone is connected to both the radio and the computer. Depending on the design of your microphone and the input impedance of the radio and computer inputs, you may get a slight bass roll-off making your audio sharper and better for DXing. This is because some microphones have a simple bass roll-off filter in the form of a series capacitor.

In the process mode or with the P6 jumper in the default position, this is NOT a consideration.

COM PORT & RIG CONTROL JUMPER DIAGRAMS (P16)

Com port Function Selection and Rig Control Selection are customized with jumpering on the P16 jumper block inside the *RIGblaster pro*. These jumpers determine which functions will be accomplished through SERIAL/COM RS232 IN/OUT A (R3) and which will be accomplished through SERIAL/COM RS232 IN/OUT B (R2). Many programs such as HamScope & MixW have the capability of using the same computer com port for PTT, CW, and Rig Control. HamScope & MixW also have the capability to use one computer com port for PTT, CW & FSK and another for Rig Control.

Because *RIGblaster pro* has the capability to facilitate both Rig Control and FSK and both require the TXD (transmitted data) line of a serial port, it is necessary to have two SERIAL/COM RS232 IN/OUT ports on the rear panel of the *RIGblaster pro*. Further flexibility is offered in the *RIGblaster pro* such that either SERIAL/COM RS232 IN/OUT “A” or “B” may be used for either of these functions. Some software applications permit multiple functions, such as PTT, CW, FSK or Rig Control (CAT), using the same computer com port and some require different ports.

Rig Control and FSK can be done from either SERIAL/COM RS232 IN/OUT port and is selected with jumpering on the P16 jumper block, however they are mutually exclusive. That is if you elect to do Rig Control on SERIAL/COM RS232 IN/OUT A, FSK would have to be done on SERIAL/COM RS232 IN/OUT B and visa versa.

Control of PTT and CW are not selectable and will be always be done through SERIAL/COM RS232 IN/OUT A, with PTT being controlled by serial port line RTS and CW being controlled by serial port line DTR. Make sure that, when you configure your software, you observe this convention.





By default the *RIGblaster pro* is jumpered from the factory to enable Rig Control on SERIAL/COM RS232 IN/OUT A and nothing on SERIAL/COM RS232 IN/OUT B.

On the jumper diagrams shown on the following pages, the left side diagrams are for Icom CI-V and TenTec TTL type Rig Control. Diagrams on the right side are for Yaesu TTL type Rig Control. The two center columns show the function assigned to the SERIAL/COM RS232 IN/OUT A & B ports of the *RIGblaster pro*.

Further flexibility is available via jumpering on the P16 block to permit pass through of TXD and RXD from SERIAL/COM RS232 IN/OUT A to SERIAL/COM RS232 IN/OUT B. This would typically be used for Rig Control when you wanted to use the same computer com port for both PTT and Rig Control and the rig already has an RS232 port for RIG control such as some Kenwood radios.

Example: Using the diagrams on the next page to set the jumpering on the P16 Jumper Block assuming you are using an Icom IC-756PRO, with the first computer serial port for PTT, CW, & Rig Control connected to the *RIGblaster pro* SERIAL/COM RS232 IN/OUT port **A** and the second computer serial port for FSK connected to the *RIGblaster* SERIAL/COM RS232 IN/OUT port **B**. Diagram number **2** below illustrates the jumpering for this example.

SERIAL/COM RS232 IN/OUT PORT FUNCTION SELECTION AND RIG CONTROL SELECTION

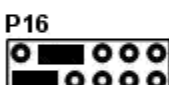
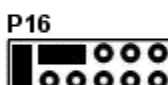
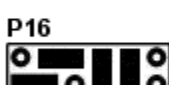
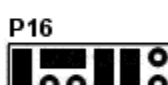
SERIAL/COM RS232 IN/OUT A	SERIAL/COM RS232 IN/OUT B	Rig Control ICOM CI-V TenTec CI-V	Rig Control Yaesu TTL
Rig Ctl PTT & CW *	Not Used	1 P16  (Factory Setting)	5 P16 
Rig Ctl PTT & CW *	FSK	2 P16 	6 P16 
FSK PTT & CW *	Not Used	3 P16 	7 P16 
FSK PTT & CW *	Rig Ctl	4 P16 	8 P16 

* PTT & CW are always on SERIAL/COM RS232 IN/OUT A as follows:
CW is controlled by DTR and PTT is controlled by RTS

9 P16 	RXD & TXD on A passed through to B For Radios with RS-232 DB9 Rig Control/CAT
--	---

PTT LOOP JUMPER – P5

The PTT LOOP JUMPER is used to loop PTT directly inside the *RIGblaster pro* or, if desired, externally via a sequencer or other device. The factory default is with a Direct Blue Shunt jumper installed on the P5 jumper block.

Method 3

This example illustrates where audio is available on a pin of the front microphone connector of the radio. As this microphone pin out diagram shows, AF output is available on pin 8 of the microphone connector. In the *RIGblaster pro*, we have added the circuitry necessary to utilize this source of receive audio. The normal *RIGblaster pro* microphone cable therefore gets the audio to the *RIGblaster pro*. Once inside the *RIGblaster pro* audio is routed to the circuitry that goes onto the computer Sound Card via additional jumpers on the P1 jumper block. In this illustration, we have added two additional white jumpers to the P1 jumper block to achieve this routing. As in method 1 the only downside is that, as the illustration says, “output varies with AF” and thus may require adjustment each time you operate. The upside is, there is no additional wiring necessary to get receive audio to the *RIGblaster pro* and the computer.

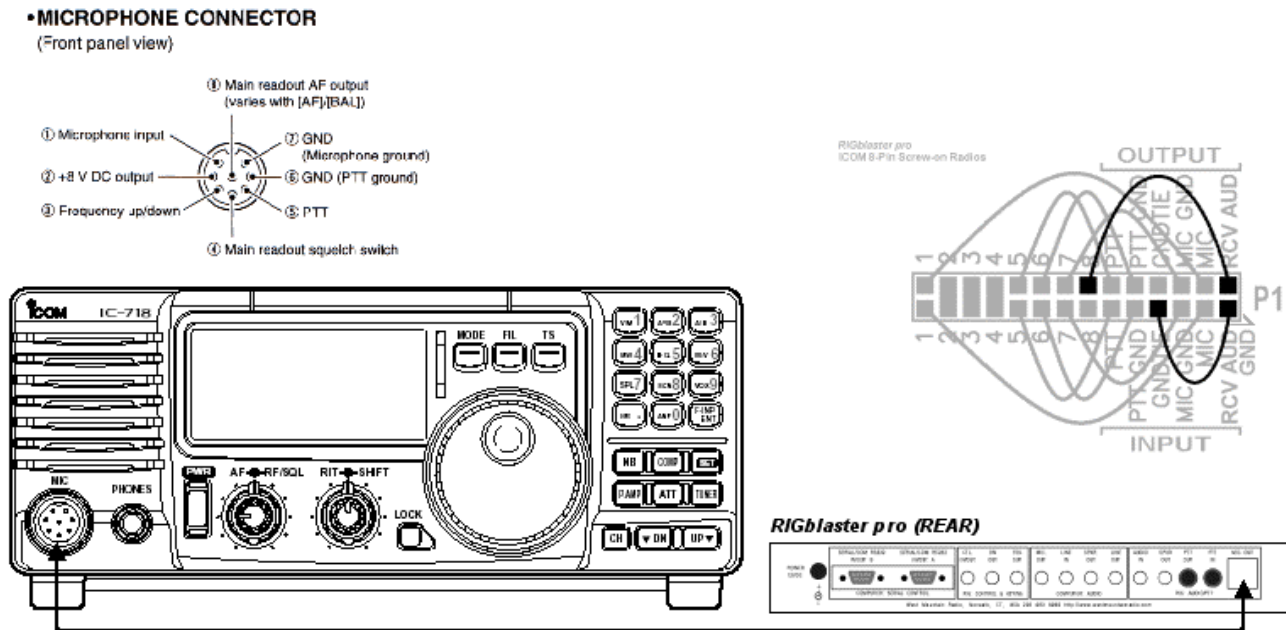

TROUBLESHOOTING TIPS

No Receive: Make sure that you can hear your receiver audio coming from your computer speakers by setting your sound card, radio and speaker controls. If all the controls are set correctly and you still do not hear your radio, it is not connected. If you can hear your radio coming out of your computer speakers but the signals do not display on your sound card software you must set your sound card recording control panel input.

Transmit PTT is not activated by sound card software: Assuming that your radio and the *RIGblaster pro* indicate transmit activation at least once during computer boot up then you have not set and configured that sound card software to activate transmit. Read the software help and make sure you have it set to communicate PTT control to the serial port that is connected to the SERIAL/COM RS232 IN/OUT A on the rear of the *RIGblaster pro*.

No sound card software transmit output: If your software activates transmit PTT that means you have the transmit audio disconnected, turned off or turned down too far. Check that you can hear transmit tones from your computer and that the level indicator on the *RIGblaster pro* is lit. Make sure that the RF drive on your radio is set to maximum and your microphone gain is normal. Turn up the level set knob until you see the desired output.

I am stuck in transmit after my computer boots up: See our support page for software problems

Your microphone does not work properly: Check to make sure the jumpers match your radio and microphone. It is usually better to pull the jumpers out and put them in again than to just check them.

When keying CW from your keyboard, the wrong characters are sent: Make sure you have the *RIGblaster pro* CW keying output, CW OUT (R5), wired to a straight key jack not a paddle jack or that you have programmed your radio for straight keying on its Key Jack.

Rig control doesn't work: Make sure the communications settings (baud, parity, stop bits, address, etc.) are set correctly. Make sure the cable is connected and the *RIGblaster pro* serial jumpers are set correctly. Make sure your radio menu settings for rig control are set the same as the software.

Microphone equalization feeds back: Check that the sound card is not set to feed the output back to the input and that your radio is not in the "monitor mode". See the software help files.

If you have read this manual and the software help and manuals:

GO TO <http://www.westmountainradio.com/support.htm>

INDEX

AUDIO IN, 7
Blue Shunt Jumpers, 3
c.s. LED, 4
CD-ROM, 3
Cover Screws, 3
CTL. IN/OUT, 6
cw LED, 5
CW OUT, 6
FRONT PANEL, 4, 5
FSK, 28
fsk LED, 5
FSK OUT, 6
HEADPHONE JACK, 4
level LED, 4
level set, 4
LINE IN, 7
LINE OUT, 7
mic 2, 4
MIC MODE JUMPER, 27
MIC OUT, 7
mic. LED, 4
MIC. OUT, 7
Microphone Cable, 3
MICROPHONE CONNECTOR, 4, 9
P1, 12, 25
P1 jumper block, 12, 25
P16 jumper block, 6, 14, 28
P5 jumper block, 30
P6, 16
P6 jumper block, 27
Patch Cord, 3
Patch Cord Labels, 3, 10
POWER INPUT, 6
power LED, 5
Power Supply, 3
power SWITCH, 5
process LED, 4
process Switch, 4
PTT IN, 7
PTT OUT, 7
ptt LED, 4
PTT LOOP JUMPER, 30
RCV AUD, 12, 25
REAR PANEL, 6, 7
Rig Control, 6, 28
Serial Cable, 3
SERIAL/COM RS232 IN/OUT **A**, 6
SERIAL/COM RS232 IN/OUT **B**, 6
SPKR OUT, 7
White Wire Jumpers, 3

***RIGblaster pro* Warranty**

RIGblaster pro is warranted against failure due to defects in workmanship or materials for one year after the date of purchase from West Mountain Radio. Warranty does not cover damage caused by abuse, accident, misuse, improper or abnormal usage, failure to follow instructions, improper installation, alteration, lightning, or other incidence of excessive voltage or current. If failure occurs within this period, return the *RIGblaster pro* or accessory to West Mountain Radio at your shipping expense. The device or accessory will be repaired or replaced, at our option, without charge, and returned to you at our shipping expense. Repaired or replaced items are warranted for the remainder of the original warranty period. You will be charged for repair or replacement of the *RIGblaster pro* or accessory made after the expiration of the warranty period.

The Compact Disc of Radio Amateur Software Collection is excluded from any and all warranties by West Mountain Radio. Note that the programs have been provided as shareware or freeware by the software authors to the amateur radio community for their use and enjoyment. The CD-ROM is to be used at your own risk.

West Mountain Radio shall have no liability or responsibility to customer or any other person or entity with respect to any liability, loss, or damage caused directly or indirectly by use or performance of the products or arising out of any breach of this warranty, including, but not limited to, any damages resulting from inconvenience, loss of time, data, property, revenue, or profit, or any indirect, special incidental, or consequential damages, even if West Mountain Radio has been advised of such damages.

Except as provided herein, West Mountain Radio makes no express warranties and any implied warranties, including fitness for a particular purpose, are limited in duration to the stated duration provided herein.

West Mountain Radio
www.westmountainradio.com

18 Sheehan Avenue, Norwalk, CT 06854 tel 203-853-8080 fax 203-299-0232

